

JVC

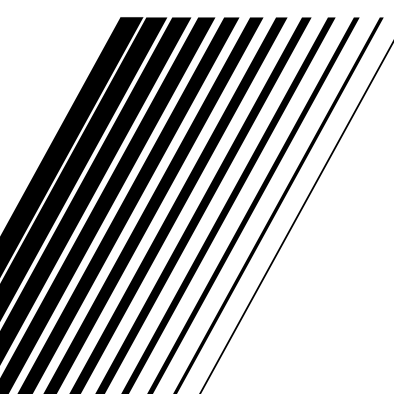

DVD PLAYER & VIDEO CASSETTE RECORDER

HR-XVC14BU HR-XVC15SU

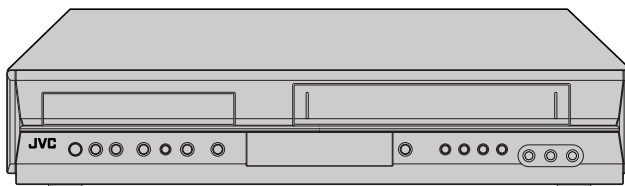
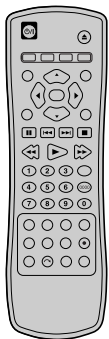

INSTRUCTIONS

For customer use:

Enter below the Model No. and Serial No. which are located on the rear of cabinet. Retain this information for future reference.

Model No. _____

Serial No. _____



CAUTION
RISK OF ELECTRIC SHOCK
DO NOT OPEN



CAUTION: TO REDUCE THE RISK OF ELECTRIC SHOCK DO NOT REMOVE COVER (OR BACK) NO USER-SERVICEABLE PARTS INSIDE REFER SERVICING TO QUALIFIED SERVICE PERSONNEL.



This lightning flash with arrowhead symbol within an equilateral triangle is intended to alert the user to the presence of uninsulated dangerous voltage within the product's enclosure that may be of sufficient magnitude to constitute a risk of electric shock to persons.



The exclamation point within an equilateral triangle is intended to alert the user to the presence of important operating and maintenance (servicing) instructions in the literature accompanying the product.

WARNING: TO REDUCE THE RISK OF FIRE OR ELECTRIC SHOCK, DO NOT EXPOSE THIS APPARATUS TO RAIN OR MOISTURE AND OBJECTS FILLED WITH LIQUIDS, SUCH AS VASES, SHOULD NOT BE PLACED ON THIS APPARATUS.

WARNING: Do not install this equipment in a confined space such as a bookcase or similar unit.

CAUTION: Do not block any ventilation openings. Install in accordance with the manufacturer's instructions.

Slots and openings in the cabinet are provided for ventilation and to ensure reliable operation of the product and to protect it from over heating.

The openings should be never be blocked by placing the product on a bed, sofa, rug or other similar surface. This product should not be placed in a built-in installation such as a bookcase or rack unless proper ventilation is provided or the manufacturer's instruction have been adhered to.

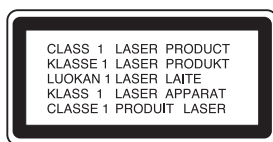

CAUTION:

This product employs a Laser System.

To ensure proper use of this product, please read this owner's manual carefully and retain it for future reference. Should the unit require maintenance, contact an authorized service center.

Performing controls, adjustments, or carrying out procedures other than those specified herein may result in hazardous radiation exposure.

To prevent direct exposure to laser beam, do not try to open the enclosure. Visible laser radiation when open. **DO NOT STARE INTO BEAM.**

CAUTION: The apparatus should not be exposed to water (dripping or splashing) and no objects filled with liquids, such as vases, should be placed on the apparatus.

REGULATORY INFORMATION: FCC Part 15

This equipment has been tested and found to comply with the limits for a Class B digital device, pursuant to Part 15 of the FCC Rules.

These limits are designed to provide reasonable protection against harmful interference in a residential installation. This equipment generates, uses and can radiate radio frequency energy and, if not installed and used in accordance with the instructions, may cause harmful interference to radio communications.

However, there is no guarantee that interference will not occur in a particular installation. If this equipment does cause harmful interference to radio or television reception, which can be determined by turning the equipment off and on, the user is encouraged to try to correct the interference by one or more of the following measures:

- Reorient or relocate the receiving antenna.
- Increase the separation between the equipment and receiver.
- Connect the equipment into an outlet on a circuit different from that to which the receiver is connected.
- Consult the dealer or an experienced radio/TV technician for help.

CAUTION concerning the Power Cord

Most appliances recommend they be placed upon a dedicated circuit;

That is, a single outlet circuit which powers only that appliance and has no additional outlets or branch circuits. Check the specification page of this owner's manual to be certain.

Do not overload wall outlets. Overloaded wall outlets, loose or damaged wall outlets, extension cords, frayed power cords, or damaged or cracked wire insulation are dangerous. Any of these conditions could result in electric shock or fire. Periodically examine the cord of your appliance, and if its appearance indicates damage or deterioration, unplug it, discontinue use of the appliance, and have the cord replaced with an exact replacement part by an authorized servicer.

Protect the power cord from physical or mechanical abuse, such as being twisted, kinked, pinched, closed in a door, or walked upon. Pay particular attention to plugs, wall outlets, and the point where the cord exits the appliance.

To disconnect power from the mains, pull out the mains cord plug. When installing the product, ensure that the plug is easily accessible.

IMPORTANT SAFETY INSTRUCTIONS

CAUTION: PLEASE READ AND OBSERVE ALL WARNINGS AND INSTRUCTIONS IN THIS OWNER'S MANUAL. AND THOSE MARKED ON THE PRODUCT. RETAIN THIS BOOKLET FOR FUTURE REFERENCE.

This product has been designed and manufactured to assure personal safety. Improper use can result in electric shock or fire hazard. The safeguards incorporated in this product will protect you if you observe the following procedures for installation, use, and servicing.

This product does not contain any parts that can be repaired by the user.

DO NOT REMOVE THE CABINET COVER, OR YOU MAY BE EXPOSED TO DANGEROUS VOLTAGE. REFER SERVICING TO QUALIFIED SERVICE PERSONNEL ONLY.

- 1. Read these instructions.** - All these safety and operating instructions should be read before the product is operated.
- 2. Keep these instructions.** - The safety, operating and use instructions should be retained for future reference.
- 3. Heed all warnings.** - All warnings on the product and in the operating instructions should be adhered to.
- 4. Follow all instructions.** - All operating and use instructions should be followed.
- 5. Do not use this product near water.** - For example: near a bath tub, wash bowl, kitchen sink, laundry tub, in a wet basement; or near a swimming pool; and other areas located near water.
- 6. Clean only with dry cloth.** - Unplug this product from the wall outlet before cleaning. Do not use liquid cleaners.
- 7. Do not block any ventilation openings. Install in accordance with the manufacturer's instructions.** - Slots and openings in the cabinet are provided for ventilation and to ensure reliable operation of the product and to protect it from over-heating. The openings should never be blocked by placing the product on a bed, sofa, rug or other similar surface. This product should not be placed in a built-in installation such as a bookcase or rack unless proper ventilation is provided or the manufacturer's instructions have been adhered to.
- 8. Do not install near any heat sources such as radiators, heat registers, stoves, or other apparatus (including amplifiers) that produce heat.**
- 9. Do not defeat the safety purpose of the polarized or grounding-type plug.** A polarized plug has two blades with one wider than the other. A grounding type plug has two blades and a third grounding prong. The wide blade or the third prong are provided for your safety. If the provided plug does not fit into your outlet, consult an electrician for replacement of the obsolete outlet.
- 10. Protect the power cord from being walked on or pinched particularly at plugs, convenience receptacles, and the point where they exit from the product.**
- 11. Only use attachments/accessories specified by the manufacturer.**
- 12. Use only with the cart, stand, tripod, bracket, or table specified by the manufacturer, or sold with apparatus. When a cart is used, use caution when moving the cart/product combination to avoid injury from tip-over.**
- 13. Unplug this product during lightning storms or when unused for long periods of time.**
- 14. Refer all servicing to qualified service personnel. Servicing is required when the product has been damaged in any way, such as power-supply cord or plug is damaged, liquid has been spilled or objects have fallen into the product, the product has been exposed to rain or moisture, does not operate normally, or has been dropped.**



Contents

Introduction	5
Moisture Condensation	5
Symbol Used in this Manual	5
About the  Symbol Display	5
Notes on Discs	5
Types of Playable Discs	6
Region Code	6
Notes on Copyrights	6
Front Panel	7
Display Windows	7
Remote Control	8
About the Remote Control	8
Rear Panel	9
Preparation	10
Basic TV Connections	10
Optional TV Connections	10
Cable/Satellite box Connection to unit	11
Accessory Audio/Video (A/V)	
Connections to unit	11
Connection to an Amplifier	12
Initial Settings - VCR	13
General Operation	13
CLOCK	13
SETUP	13
Displaying Disc Information on-screen	14
Initial Settings - DVD	14-17
General Operation	14
LANGUAGE	15
• Menu Language	15
• Disc Audio/Subtitle/Menu	15
DISPLAY	15
• TV Aspect	15
• Display Mode	15
• Progressive Scan	15
AUDIO	16
• Dolby Digital/DTS/MPEG	16
• Sample Freq. (Frequency)	16
• Dynamic Range Control (DRC)	16
• Vocal	16
OTHERS	16
PBC	16
B.L.E. (Black Level Expansion)	16
DivX(R) VOD	16
Remote Control Function	16

Operation18

VCR Tape Playback	18
Basic Instructions	18
Auto Tracking	18
Manual Tracking	18
Search	18
Still Picture and Frame-by-Frame Playback	18
Slow Motion	18
CM SKIP (Commercial Skip)	19
VCR Tape Recording	19-20
Basic Recording (One-Touch Recording)	19
Instant Timer Recording	19
Manual Timer Programming	20
Timer-Link Recording (External Timer Recording)	21
Copying from DVD to VCR	22
On-Screen Display - VCR	22
Additional VCR Information	23
VCR Auto Play System	23
S-VHS Quasi Playback (SQPB)	23
DVD Disc Playback (General Features)	24
Additional Features	25
Playing an Audio CD	26
Programmed Playback	26
Repeat Programmed Tracks	26
Erasing a Track from Program List	26
Erasing the Complete Program List	26
Viewing a JPEG file	27
Slide Show	27
Still Picture	27
Moving to another File	27
Zoom	27
Rotating the picture	27
Playing a DivX Movie file	28
Playing a DVD VR format Disc	29
Maintenance and Service	29

Reference30

Language Codes	30
Troubleshooting	31-32
Specifications	33

Introduction

To ensure proper use of this product, please read this owner's manual carefully and retain it for future reference.

This manual provides information on the operation and maintenance of your unit. Should the unit require service, contact an authorized service location.

Moisture Condensation

Never operate the unit immediately after moving it from a cold location to a warm location. Leave it unplugged for two or three hours without operating it. If you use the unit in such a situation, it may damage discs/tapes and internal parts.

Symbol Used in this Manual

Note: Indicates special notes and operating features.

Tip: Indicates tips and hints for making the task easier.

A section whose title has one of the following symbols is applicable only to the disc represented by the symbol.

- ALL** All discs listed below
- DVD** DVD and finalized DVD±R/RW
- VCD** Video CDs
- ACD** Audio CDs
- DivX** DivX files

About the Symbol Display

“” may appear on your TV display during operation and indicates that the function is not permitted by this unit or the disc.

Notes on Discs

Handling Discs

Do not touch the playback side of the disc. Hold the disc by the edges so that fingerprints do not get on the surface. Never stick paper or tape on the disc.



Storing Discs

After playing, store the disc in its case. Do not expose the disc to direct sunlight or sources of heat and never leave it in a parked car exposed to direct sunlight.



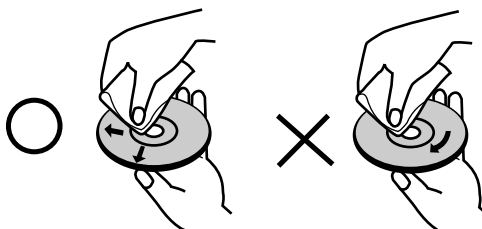

Cleaning Discs

Fingerprints and dust on the disc can cause poor picture quality and sound distortion. Before playing, clean the disc with a clean cloth. Wipe the disc from the center out.



Do not use strong solvents such as alcohol, benzine, thinner, commercially available cleaners, or anti-static spray intended for older vinyl records.

Types of Playable Discs

	DVD (8 cm / 12 cm disc)
 	Video CD (VCD) (8 cm / 12 cm disc)
	Audio CD (8 cm / 12 cm disc)

RW In addition, this unit plays DVD±R/RW, CD-
COMPATIBLE R/RW and SVCD, Dual disc that contains
audio titles, DivX, and/or JPEG files.

This indicates a product feature that is capable of playing DVD-RW discs recorded with Video Recording format.

Notes:

- Depending on the conditions of the recording equipment or the CD-R/RW (or DVD±R/RW) disc itself, some CD-R/RW (or DVD±R/RW) discs may not be played on the unit.
- Do not use irregularly shaped CDs (e.g., heart-shaped or octagonal) since they may result in malfunctions.
- This unit requires discs and recordings to meet certain technical standards in order to achieve optimal playback quality. Pre-recorded DVDs are automatically set to these standards. There are many different types of recordable disc formats and these require certain pre-existing conditions (see above) to ensure compatible playback.

Regional Code

This unit has a regional code printed on the rear of the unit. This unit can play only DVD discs labeled as the same as the rear of the unit or "ALL".



Notes on Regional Codes

- Most DVD discs have a globe with one or more numbers in it clearly visible on the cover. This number must match your DVD player's regional code or the disc cannot play.
- If you try to play a DVD with a different regional code from your player, the message "Check Regional Code" appears on the TV screen.

Notes on Copyrights:

It is forbidden by law to copy, broadcast, show, broadcast via cable, play in public, or rent copyrighted material without permission. This product features the copy protection function developed by Macrovision. Copy protection signals are recorded on some discs. When recording and playing the pictures of these discs picture noise will appear. This product incorporates copyright protection technology that is protected by method claims of certain U.S. patents and other intellectual property rights owned by Macrovision Corporation and other rights owners. Use of this copyright protection technology must be authorized by Macrovision Corporation, and is intended for home and other limited viewing uses only unless otherwise authorized by Macrovision Corporation. Reverse engineering or disassembly is prohibited.

Notice for Progressive Scan Use

CONSUMERS SHOULD NOTE THAT NOT ALL HIGH DEFINITION TELEVISION SETS ARE FULLY COMPATIBLE WITH THIS PRODUCT AND MAY CAUSE ARTIFACTS TO BE DISPLAYED IN THE PICTURE. IN CASE OF 525 PROGRESSIVE SCAN PICTURE PROBLEMS, IT IS RECOMMENDED THAT THE USER SWITCH THE CONNECTION TO THE 'STANDARD DEFINITION' OUTPUT. IF THERE ARE QUESTIONS REGARDING YOUR TV SET COMPATIBILITY WITH THIS MODEL 525p unit RECORDER, PLEASE CONTACT OUR CUSTOMER SERVICE CENTER.

Front Panel

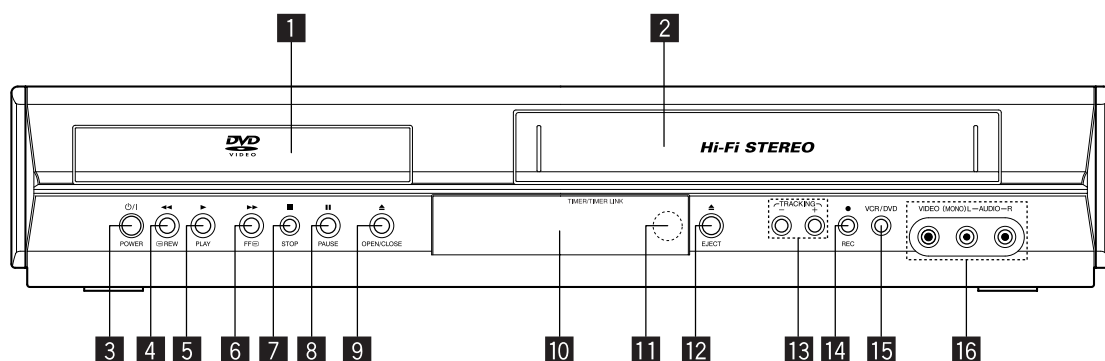

- 1 Disc Tray (DVD deck)**
Insert a disc here.
- 2 Cassette Compartment (VCR deck)**
Insert a video cassette here.
- 3 POWER**
Switches the unit ON and OFF.
- 4 REW ()**
- **DVD:** Skip to beginning of current chapter or track, press twice in quick successions to go to previous chapter or track. Press and hold button for about two seconds to search backward.
- **VCR:** Rewinds the tape during the stop mode or for fast reverse picture search.
- 5 PLAY ()**
Starts playback of a disc or tape.
- 6 FF ()**
- **DVD:** Skip to next chapter or track. Press and hold for two seconds for a fast forward search.
- **VCR:** Advances the tape during the STOP mode or for fast forward picture search.
- 7 STOP ()**
Stops playback of the disc or tape.
- 8 PAUSE ()**
Pause playback or recording. Press repeatedly for frame-by-frame playback.
- 9 OPEN/CLOSE ()**
Opens or closes the disc tray.
- 10 Display Windows**
Refer to below for details.
- 11 Remote Sensor**
Point the unit Remote Control here.
- 12 EJECT ()**
Ejects the tape in the VCR deck.
- 13 TRACKING +/-**
To adjust tracking.
- 14 REC ()**
To record normally or to activate One-touch Timer Recording by repeated presses.
Press REC () for more than 3 seconds to set the unit to standby mode for Timer-Link recording.
- 15 VCR/DVD (output select)**
Select one of your output sources to view on the TV screen between DVD and VCR.
- 16 LINE2 (VIDEO/AUDIO (L/R) input)**
Connect to the audio/video output of an external source (Audio system, TV/Monitor, Another VCR).

Display Windows

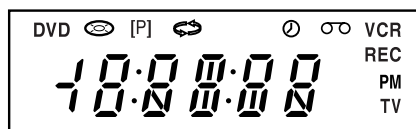

- DVD** The DVD deck is selected.
- A disc is in the DVD deck.
(Lights when a disc is in the DVD deck and Flashes when no disc.)
- [P] Indicates when the Progressive scan is active.
- Indicates repeat mode.
- The unit is in timer recording or a timer recording is programmed (VCR part only).
This indicator will flash when the unit is set to standby mode for Timer-Link recording.
- A cassette is in the VCR deck.
- VCR** The VCR deck is selected.
- REC** The unit is Recording. (VCR part only)
- PM** Indicates PM time. (AM is not displayed.)
- TV** Lights when TV mode is active.
- Indicates total playing time, elapsed time, remaining time or current deck status (Playback, Pause, etc.).

Remote Control

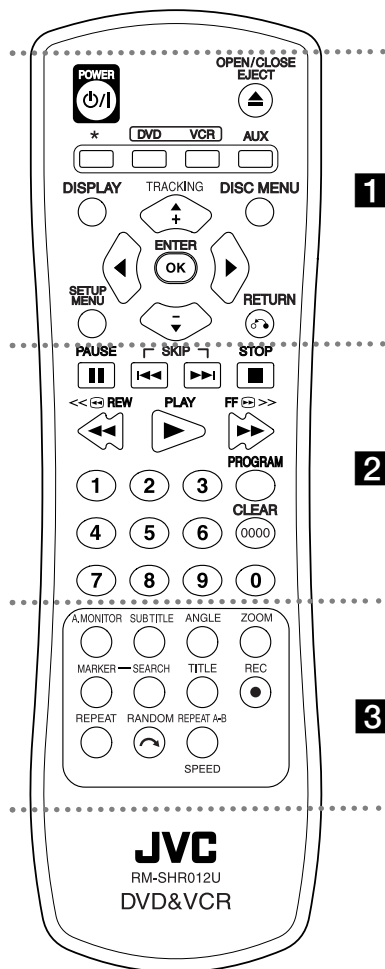

• • • • • **1** • • • • •

⏻/⏿ (POWER) : Switches unit ON and OFF.

* : This button is not available.

⏮ (OPEN/CLOSE) : Opens and closes the disc tray.

DVD : Select the unit function mode to DVD.

VCR : Select the unit function mode to VCR.

AUX : Selects the VCR deck's source (LINE 1 or LINE 2).

DISPLAY : Accesses On-Screen Display.
Switches between the clock, tape counter and tape remaining modes on the display.

DISC MENU : Accesses menu on a DVD disc.

◀ / ▶ / ▲ / ▼ : Selects menu options.

TRACKING (-/+) : Adjusts manually the tape's picture onscreen.

SETUP/MENU : Accesses or removes DVD Setup menu and VCR menu.

ENTER (OK) : Confirms menu selections. Displays functions on the TV screen.

RETURN (↶) : Removes the setup menu.

• • • • • **2** • • • • •

⏸ (PAUSE/STEP) :

Pause playback or recording temporarily.
Press repeatedly for frame-by-frame playback.

⏮/⏭ (SKIP) (DVD only):

Go to next the chapter or track.
Returns to beginning of current chapter or track or go to previous chapter or track.

■ (STOP) : Stops playback or recording.

⏮ (REW) / ⏭ (FF):

- **DVD**: Search backward or forward.
- **VCR**: Rewinds/Advances the tape during the STOP mode, for fast backward/forward picture search.

▶ (PLAY) : Starts playback.

0-9 Selects numbered options in a menu.

PROGRAM : Shows or hides Program menu.

CLEAR (0000) : Removes a mark on the Marker Search menu.

• • • • • **3** • • • • •

A.MONITOR : Selects an audio language (DVD).

SUBTITLE : Selects a subtitle language.

ANGLE : Selects a DVD camera angle, if available.

ZOOM : Enlarges DVD video image.

MARKER : Marks any point during playback.

SEARCH : Displays Marker Search menu.

TITLE : Displays the disc's Title menu, if available.

● (REC) : Starts recording.

REPEAT : Repeat chapter, track, title or all.

RANDOM : Plays tracks in random order.

↶ : Fast forwards picture search through 30 seconds of recording.

REPEAT A-B : Repeats sequence between two points (A and B).

SPEED : Selects recording speed. Shows tape playing speed.

About the Remote Control

Operation Range

Point the Remote Control at the remote sensor and press the buttons.

Distance: About 23 ft (7 m) from the front of the remote sensor.

Angle: About 30° in each direction of the front of the remote sensor.

Battery installation

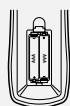

Detach the battery cover on the rear of the Remote Control, and insert two (R03/AAA) size batteries with ⊕ and ⊖ aligned correctly.



Do not mix old and new batteries and never mix different types of batteries such as standard, alkaline, etc.

Rear Panel



Caution

Do not touch the inner pins of the jacks on the rear panel.
Electrostatic discharge may cause permanent damage to the unit.

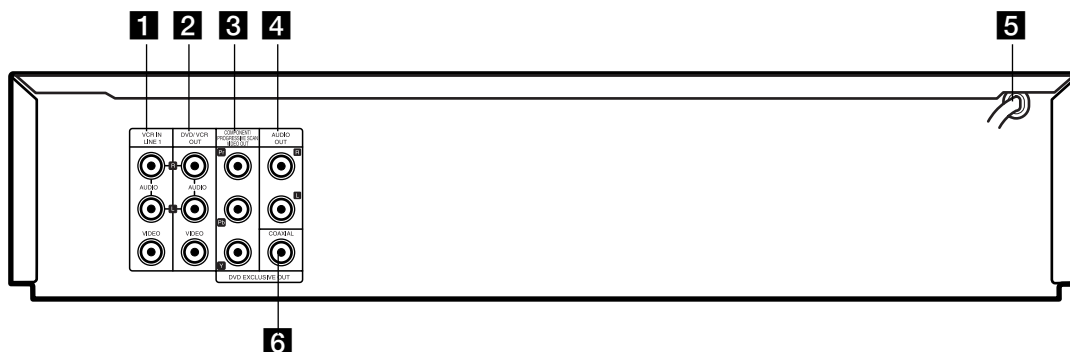

- 1 VCR IN LINE 1 (VIDEO/AUDIO (Left/Right))**
Connect the audio/video output of an external source (Cable/Satellite box, Audio system, TV/Monitor, VCR, Camcorder).
- 2 DVD/VCR OUT (VIDEO/AUDIO (Left/Right))**
Connect to a TV with video and audio inputs.
- 3 COMPONENT/PROGRESSIVE SCAN VIDEO OUT (Y Pb Pr) (DVD EXCLUSIVE OUT)**
Connect to a TV with Y Pb Pr inputs.
- 4 AUDIO OUT (Left/Right) (DVD EXCLUSIVE OUT)**
Connect to a TV or other equipment with audio inputs.

- 5 AC Power Cord**
Plug into the power source.
- 6 COAXIAL (DIGITAL AUDIO OUT jack) (DVD EXCLUSIVE OUT)**
Connect to digital (coaxial) audio equipment.

Preparation

Depending on your TV and other equipment there are various ways you can connect the player. Please refer to the manuals of your TV, VCR, stereo system or other devices as necessary for additional connection information.

Notes:

- The picture and sound of a nearby TV, VCR, or radio may be distorted during playback. Position the units away from each other or turn off the unit after removing the disc.
- Do not connect the unit's AUDIO OUT jack to the phono in jack (record deck) of your audio system. Do not connect the unit via another VCR. The DVD image could be distorted by the copy protection system.

Basic TV Connections

Make one of the following connections, depending on the capabilities of your TV.

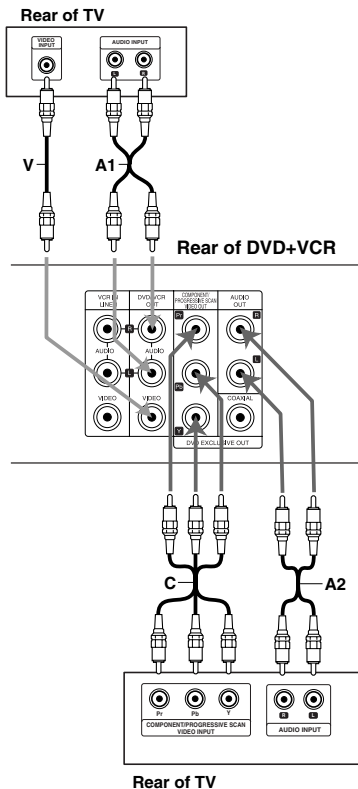

Audio/Video connection

1. Connect the DVD/VCR VIDEO OUT jack on the unit to the video in jack on the TV using the video cable supplied (V).
2. Connect the Left and Right DVD/VCR AUDIO OUT jacks on the unit to the audio left/right in jacks on the TV using the supplied audio cables (A1).

Note:

If you use this connection, set the TV's source selector to VIDEO.

Optional TV Connections

These connections support only DVD playback. The tuner and VCR still output through the DVD/VCR OUT (A1, V) jacks.

Component Video / Progressive Scan connection

If your television is a high-definition or "digital ready" television, you may take advantage of the unit's progressive scan output for the highest possible video resolution.

Connect the COMPONENT/PROGRESSIVE SCAN VIDEO OUT jacks on the unit to the corresponding jacks on the TV using an optional Y Pb Pr cable (C).

Audio connection

Connect the Left and Right AUDIO OUT jacks of the unit to the audio left/right in jacks on the TV using the supplied audio cables (A2).

Note:

If you connect both composite and component jacks to TV, the picture may be unstably on the TV. You could disconnect one of them to solve this problem.

Cable/Satellite box Connection to unit

To use Timer-Link Recording, connect the VCR IN LINE 1 jacks on the unit to the audio/video out jacks on your Cable/Satellite box, using the optional audio/video cables.

(Refer to page 21 for “Timer-Link Recording”.)

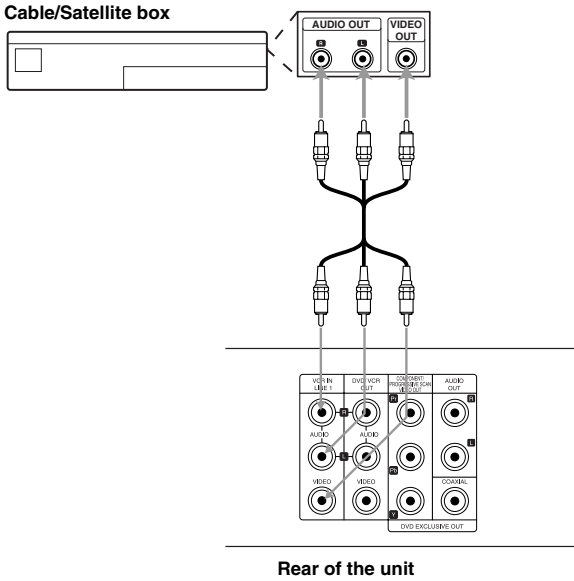

Accessory Audio/Video (A/V) Connections to unit

Connect the VCR IN LINE 1 or LINE 2 jacks on the unit to the audio/video out jacks on your accessory component, using the optional audio/video cables. (Refer to page 19 for “Basic Recording”.)

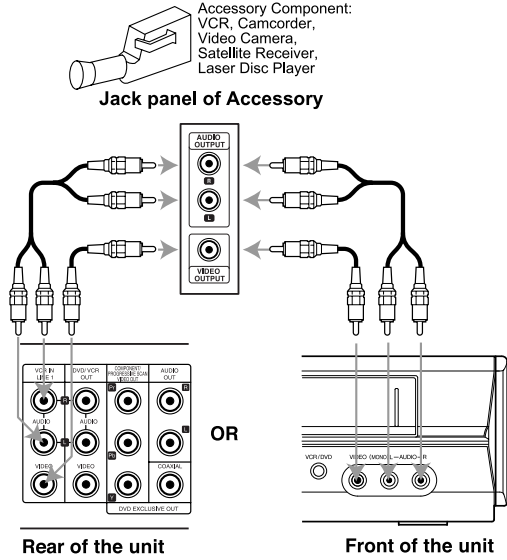

Connection to an Amplifier

You can only listen to DVD playback using COAXIAL (X) and AUDIO OUT (A2) connections. The VCR will still be heard through the DVD/VCR AUDIO OUT (A1) jack.

Connecting to an amplifier equipped with two channel analog stereo or Dolby Pro Logic II/Pro Logic

Connect the Left and Right AUDIO OUT (or DVD/VCR AUDIO OUT) jacks on the unit to the audio left and right in jacks on your amplifier, receiver, or stereo system using the audio cables (A1, A2) supplied.

Connecting to an amplifier equipped with two channel digital stereo (PCM) or to an Audio/Video receiver equipped with a multi-channel decoder (Dolby Digital™, MPEG 2, or DTS)

1. Connect one of the unit's DIGITAL AUDIO OUT jacks (COAXIAL X) to the corresponding jack on your amplifier. Use an optional digital (COAXIAL X) audio cable.
2. You will need to activate the unit's digital output. (See "AUDIO" on page 16).

Digital Multi-channel sound

A digital multi-channel connection provides the best sound quality. For this you need a multi-channel Audio/Video receiver that supports one or more of the audio formats supported by your unit (MPEG 2, Dolby Digital and DTS). Check the receiver manual and the logos on the front of the receiver.

Caution

Due to the DTS Licensing agreement, the digital output will be in DTS digital out when DTS audio stream is selected.

Notes:

- If the audio format of the digital output does not match the capabilities of your receiver, the receiver will produce a strong, distorted sound or no sound at all.
- Six Channel Digital Surround Sound via digital connection can only be obtained if your receiver is equipped with a Digital Multi-channel decoder.
- To see the audio format of the current DVD in the on-screen display, press A.MONITOR.

Rear of the unit

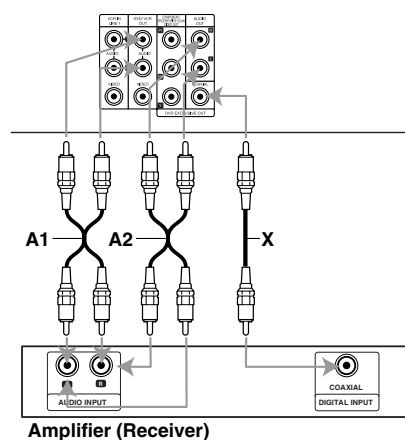

Manufactured under license from Dolby Laboratories. "Dolby", "Pro Logic", and the double-D symbol are trademarks of Dolby Laboratories.

"DTS" and "DTS Digital Out" are registered trademarks of DTS, Inc.

Initial Settings - VCR

By using the VCR Setup menu, you can make various adjustments to items such as clock setting, and timer recordings.

Your unit allows remote control adjustment of several features.

General Operation

1. Press VCR on the Remote Control.
2. Press SETUP MENU and the MAIN menu will appear.



3. Use ▲/▼ to select the desired menu, then press ENTER (OK).
4. Use ▲/▼ to choose a desired option on the selected Menu. Then use ◀/▶ to choose a desired setting.
5. Press SETUP MENU when finished.

Note:

Menus remain on-screen for 3 minutes.

CLOCK



Use ▲/▼/◀/▶ to enter the necessary information.

- MONTH : Choose the month.
- DAY : Choose the date.
The day of the week will display automatically.
- YEAR : Choose the year.
- TIME : Choose the time.
Press and hold ◀/▶ to advance clock continuously.

Note:

The clock uses the 12-hour system. Be sure to set AM and PM correctly.

SETUP



FUNCTION OSD

The on-screen display can be turned on or off.

AUDIO MODE

The unit has two separate audio playback systems, the high quality VHS Hi-Fi system and standard NORMAL mono system. The same audio is generally recorded on both systems. The VHS Hi-Fi system plays on separate (left and right) channels, and the NORMAL system plays monaural sound. The normal track is always played so the cassette can be played on a unit that does not have VHS Hi-Fi.

AUDIO OUTPUT (STEREO/LEFT/RIGHT)

Used during playback [when AUDIO MODE (HI-FI/NORMAL) is in HI-FI position] for selecting the audio output signals from the AUDIO OUT terminals (L ch and R ch). This display setting should normally be left in the stereo position, so that when a stereo tape is played, the stereo sound will be heard through the left and right channels. If a mono tape is played and the audio output is set to stereo, the same mono sound will be heard from both left and right channels.

Displaying Disc Information on-screen

You can display various information about the disc loaded on-screen.

1. Press DISPLAY to show various playback information.
The displayed items differ depending on the disc type or playing status.



2. You can select an item by pressing ▲ / ▼ and change or select the setting by pressing ◀ / ▶.
 - Title (Track) – Current title (or track) number/total number of titles (or tracks).
 - Chapter – Current chapter number/total number of chapters.
 - Time – Elapsed playing time.
 - Audio – Selected audio language or channel.
 - Subtitle – Selected subtitle.
 - Angle – Selected angle/total number of angles.

Note:

If no button is pressed for a few seconds, the on-screen display disappears.

Initial Settings - DVD

By using the Setup menu, you can make various adjustments to items such as picture and sound. You can also set a language for the subtitles and the Setup menu, among other things. For details on each Setup menu item, see pages 15 to 16.

To display and exit the Menu:

Press SETUP MENU to display the menu. A second press of SETUP MENU will take you back to initial screen.

To go to the next level:

Press ▶ on the Remote Control.

To go back to the previous level:

Press ◀ on the Remote Control.

General Operation

1. Press DVD button.
2. Press SETUP MENU. The Setup menu appears.

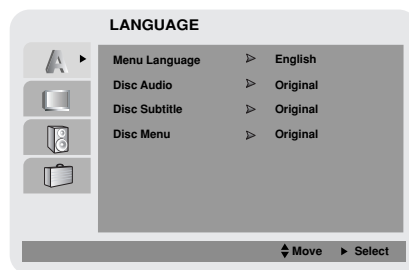

3. Use ▲ / ▼ to select the desired option then press ▶ to move to the second level. The screen shows the current setting for the selected item, as well as alternate setting(s).
4. Use ▲ / ▼ to select the second desired option then press ▶ to move to the third level.
5. Use ▲ / ▼ to select the desired setting then press ENTER (OK) to confirm your selection. Some items require additional steps.
6. Press SETUP MENU or ▶ (PLAY) to exit the Setup menu.

LANGUAGE

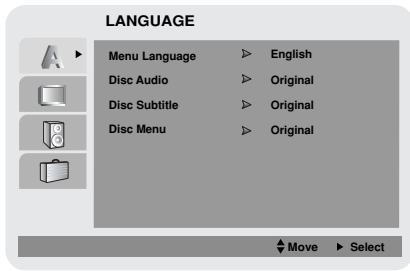

Menu Language

Select a language for the Setup menu and on-screen display.

Disc Audio / Subtitle / Menu

Select the language you prefer for the audio track (disc audio), subtitles, and the disc menu.

Original – Refers to the original language in which the disc was recorded.

Other – To select another language, press number buttons then ENTER (OK) to enter the corresponding 4-digit number according to the language code list on page 30. If you enter the wrong language code, press CLEAR (0000).

DISPLAY

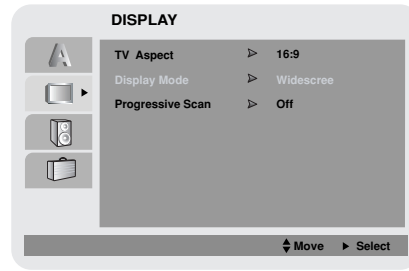

TV Aspect

4:3 – Select when a standard 4:3 TV is connected.

16:9 – Select when a 16:9 wide TV is connected.

Display Mode

The display Mode setting works only when the TV Aspect mode is set to “4:3”.

Letterbox – Displays a wide picture with bands on the upper and lower portions of the screen.

Panscan – Automatically displays the wide picture on the entire screen and cuts off the portions that do not fit.

Progressive Scan

Progressive Scan Video provides the highest quality pictures with less flickering.

If you are using the Component Video jacks for connection to a TV or a monitor that is compatible with a progressive scan signal, set Progressive Scan to On.

To Turn ON progressive scan:

Connect component video out of the this unit to the input of your monitor/television, set your television or monitor to Component Input.

1. Select “Progressive Scan” on the DISPLAY menu then press ►.
2. Select “On” using the ▲ / ▼ buttons.
3. Pressing ENTER (OK) will set the player to Progressive scan mode.

AUDIO

Each DVD disc has a variety of audio output options. Set the player's AUDIO options according to the type of audio system you use.

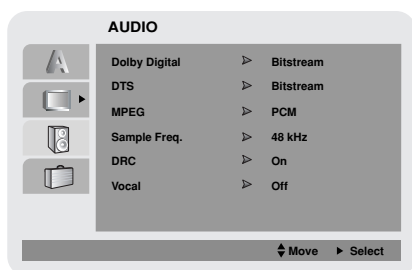

Dolby Digital / DTS / MPEG

Bitstream – Select “Bitstream” if you connect this DVD player's DIGITAL OUT jack to an amplifier or other equipment with a Dolby Digital, DTS or MPEG decoder.

PCM (for Dolby Digital / MPEG) – Select when connected to a two-channel digital stereo amplifier. DVDs encoded in Dolby Digital or MPEG will be automatically downmixed to two-channel PCM audio.

Off (for DTS): If you select “Off”, the DTS signal is not output through the DIGITAL OUT jack.

Sample Freq. (Frequency)

If your receiver or amplifier is NOT capable of handling 96 kHz signals, select 48 kHz. When this choice is made, this unit automatically converts any 96 kHz signals to 48 kHz so your system can decode them.

If your receiver or amplifier is capable of handling 96 kHz signals, select 96 kHz.

Check the documentation for your amplifier to verify its capabilities.

Dynamic Range Control (DRC)

With the DVD format, you can hear a program's soundtrack in the most accurate and realistic presentation. However, you may wish to compress the dynamic range of the audio output (the difference between the loudest sounds and the quietest ones). This allows you to listen to a movie at a lower volume without losing clarity of sound. Set DRC to On for this effect.

Vocal

Set to On only when a multi-channel karaoke DVD is playing. The karaoke channels on the disc mix into normal stereo sound.

OTHERS

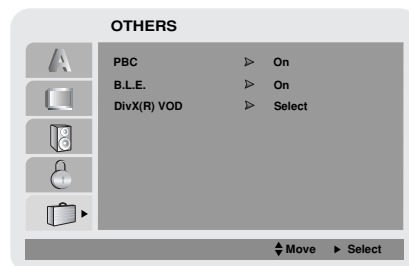

PBC **VCD**

Set Playback Control (PBC) to On or Off.

On: Video CDs with PBC are played according to the PBC.

Off: Video CDs with PBC are played the same way as Audio CDs.

B.L.E. (Black Level Expansion)

To select the black level of playback pictures. Set your preference and monitor's ability.

On: Expanded grey scale. (0 IRE cut off)

Off: Standard grey scale. (7.5 IRE cut off)

DivX(R) VOD

We provide you the DivX[®] VOD (Video On Demand) registration code that allows you to rent and purchase videos using the DivX[®] VOD service. For more information, visit www.divx.com/vod.

1. Select “DivX(R) VOD” option then press ►.
2. Press ENTER (OK) while “Select” is selected and the registration code will appear. Use the registration code to purchase or rent the videos from DivX[®] VOD service at www.divx.com/vod. Follow the instructions and download the video onto a disc for playback on this unit.
3. Press ENTER (OK) to exit.

Note:

All the downloaded videos from DivX[®] VOD can only be played back on this unit.

Remote Control Function

Remote Control A/B/C Code Switching

The remote control is capable of controlling three JVC video units independently. Each of the units can respond to one of three codes (A, B or C). The remote control is preset to send C code signals because your unit is initially set to respond to C code signals. You can easily modify your unit to respond to A or B code signals.

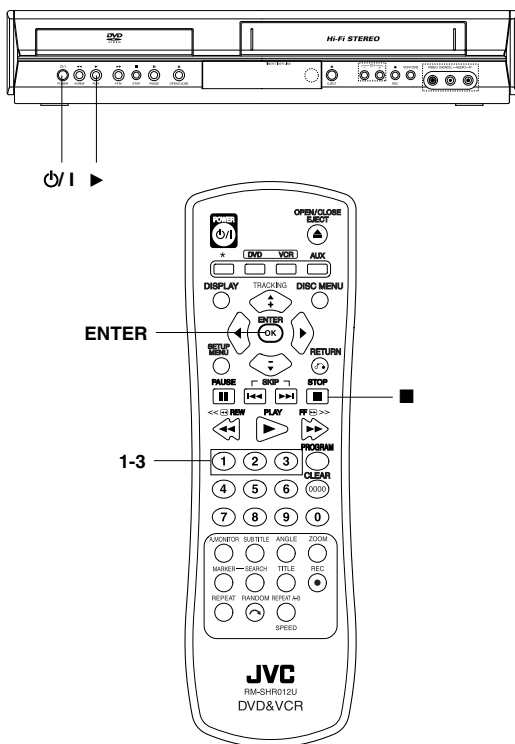

- Keep pressing ENTER (OK) down during step 1.
1. Press the **number Key "1"** for A, **"2"** for B or **"3"** for C to change the remote control code.
 2. Ensure the unit in VCR mode, and then turn off the power.
 3. Press ► on the unit for over 5 seconds while the unit is turned off. The code currently set appears on the front display panel.
 4. Press ■ (STOP) on the remote control to change the unit's code. The code currently set on the remote control blinks on the front display panel for approximately 5 seconds, and is applied to the unit.







Operation

This chapter describes how to operate the VCR and DVD.

VCR Tape Playback

Press the **VCR** button to select the device to be operated.

Basic Instructions

1. Turn on the TV.
2. Direct VIDEO/AUDIO connection is made between the unit and the TV, set the TV's source selector to VIDEO.
3. Insert a pre-recorded video cassette.
The  indicator lights and the unit powers on automatically.
4. If a tape without a safety tab is inserted the unit starts playback automatically.
If not, press  (PLAY).
5. Press  (STOP) to stop playback. If the tape reaches the end before you press  (STOP) the unit automatically stops, rewinds and ejects the tape.
6. Fast wind tape:
Press  (REW) or  (FF) during stop.

Note:

It is not necessary to select the tape speed for playback because it is automatically selected by the unit.

Auto Tracking

Automatic tracking adjusts the picture to remove snow or streaks and beings when:

- A tape is played for the first time.
- The tape speed (SP, LP, SLP) changes.
- Streaks or snow appear due to scratches on the tape.

Manual Tracking

To manually adjust the tracking use the  (-/+) buttons on the Remote Control during playback.





Notes:

- Vertical jitter requires a very fine adjustment.
- Tracking is automatically reset to normal when the tape is ejected or the power cord is unplugged for more than 3 seconds.

Search

This function lets you visually search for a tape section in either direction: forward and backward. During the high-speed picture search modes, the audio is muted and horizontal lines (noise bars) appear. Also, a short time is needed to stabilize the tape speed when re-entering the PLAY mode so slight interference may be observed during this time.





To search:

1. Press  (REW) or  (FF) during playback.
Press and hold  (REW) or  (FF) during tape fast winding.
2. To return to playback, press  (PLAY).

Note:

After 3 minutes in SEARCH mode the unit returns to PLAY mode to protect the tape and video heads.



Still Picture and Frame-by-Frame Playback

1. Press  (PAUSE) during playback.
A still picture appears on the TV screen and the audio is muted.
2. If the still picture vibrates vertically, stabilize it by using  (-/+) on the Remote Control.
3. Press  (PAUSE) repeatedly to advance the video picture one frame at a time.
4. To return to playback, press  (PLAY).

Note:

After 5 minutes in STILL mode the unit stops to protect the tape and video heads.

Slow Motion

1. While in still mode, press  (FORWARD).
The tape is played at a speed 1/19 times slower than the normal speed.
2. Use  (-/+) on the Remote Control if necessary to adjust the tracking.
3. To return to the normal speed, press  (PLAY).

Notes:

- During slow motion, audio is muted and horizontal lines (noise bars) may appear on the TV screen. This is normal.
- After 3 minutes in SLOW MOTION mode the unit goes back to PLAY mode to protect the tape and video heads.

CM SKIP (Commercial Skip)

This feature is useful for skipping commercials or short program segments.

1. Press **↶** in playback mode.
The unit performs a fast forward picture search through 30 seconds of recording.
2. Press **↶** again to extend the search time by an addition 30 seconds. The maximum search time is 3 minutes.
3. When the search is complete, the unit goes into playback mode automatically.

VCR Tape Recording

Basic Recording (One-Touch Recording)

You can record from an external component, such as a camcorder or VCR, connected to any of the unit's external inputs.

1. Make sure that the component you want to record from is connected properly to the unit. See page 11.
2. Press AUX repeatedly to select the external input to record from.
 - LINE1 (L1): Audio/Video Input mounted on back panel.
 - LINE2 (L2): Audio/Video Input mounted on front panel.
3. Load a recordable tape.
4. Set a recording mode (SP or SLP) as necessary by pressing SPEED repeatedly.
5. Play the tape or disc in the external component. If you have a TV attached to your unit, you can see the video playing.
6. Press **●** (REC) once to start recording. The REC indicator lights in the display window.
7. Press **■** (STOP) to stop recording.

Notes:

- Before recording, confirm the recording start position.
- If your source is copy-protected using CopyGuard, you will not be able to record it using this unit. See Copyright on page 6 for more details.
- To record for a fixed length of time, see Instant Timer Recording.

To pause the recording

1. Press **||** (PAUSE) to pause the tape during recording. The REC indicator flashes in the display window.
2. When you want to continue recording, press **||** (PAUSE) or press **●** (REC).
After 5 minutes in PAUSE mode, the unit stops automatically to protect the tape and the video heads.

Instant Timer Recording

With this feature you can record for a preset length without using the program timer.

Note:

Instant Timer recording is not available when the external timer record is in progress.

1. Turn on unit and the TV.
2. Insert a video cassette with the safety tab intact.
3. If you are recording from another source via audio/video input jacks (at the rear or front panel).
4. Connect the LINE1 or LINE2 input jacks on this unit to the AUDIO/VIDEO OUTPUT jack on the external device using the audio/video cables.
5. Select LINE1 (rear jacks) or LINE2 (front jacks) by using AUX.
6. Set the desired recording speed (SP or SLP) using SPEED. The tape speed appears on the TV screen.
7. Press **●** (REC) twice. The menu appears on the TV screen, recording starts, and the **⌚** (TIMER) indicator lights.

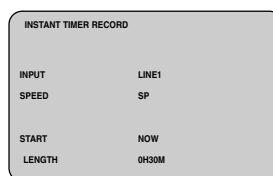

8. Press **■** (STOP) repeatedly to select the recording time length. Each time you press this button the recording time increases 30 minutes (up to 9 hours). At the end of the recording, the unit will stop recording and shut off.
If you set the time to 0H00M, the unit goes into the normal recording mode.
9. Press **■** (STOP) to stop the recording.

Checking the Recording Time

Press **●** (REC) once to check the recording time. The recalled setting automatically returns to the TV screen after 6 seconds.

Extending the Recording Time

The recording time can be extended anytime by pressing **●** (REC). Subsequent presses result in advancing the recording time by 30-minute increments.

Note:

If you press **||** (PAUSE) during instant timer recording, the instant timer recording is cancelled. It goes to normal recording PAUSE mode.

Manual Timer Programming

1. Press **SETUP MENU** and the main menu appears.
2. Use **▲ / ▼** to choose the **PROGRAM** option and press **ENTER (OK)**.

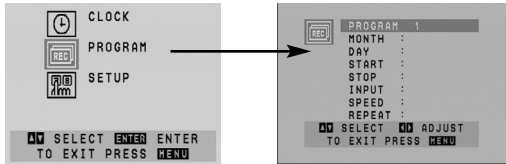

If eight programs are already entered, the **FULLY PROGRAMMED** message appears for a moment and then **PROGRAM 1** appears on the TV screen.

3. Use the **▲ / ▼** buttons to switch between the program options, and the **◀ / ▶** buttons to input the program information:

Input the **MONTH**, **DAY**, **START** and **STOP** times of the program you want to record.

INPUT: Select a **LINE1** or **LINE2**.

SPEED: **AUTO** mode determines how much tape is left and switches the speed from **SP** to **SLP** if it is necessary to complete recording the program. If this occurs there could be some picture and sound distortion at the point where the speed changes.

REPEAT: To record up to 8 programs on a certain day of every week select **WEEKLY**. To record up to 8 programs at the same time Monday through Friday select **DAILY**. Otherwise select **ONCE**.

4. Press **SETUP MENU** and the program is memorized by the unit.
5. Additional programs may be entered by repeating steps 1-4.

Notes:

- Ensure you insert a tape with the record safety tab intact before the first programmed time.
- Press **■ (STOP)** to end timer recording.
- If you make a mistake or want to change a setting, use **▲** to select the option and correct it using **◀ / ▶**.
- If the program preset time is past, the **"PAST TIME PROGRAMMED"** message appears on the TV screen. Return to the incorrect program and program it with the correct time.
- If you enter a past date, the timer recording will be performed on that date of the next year.

- If the power fails or the unit is unplugged the clock and timer settings are kept in memory for only 3 seconds. Otherwise you must reset the clock and timer.
- If the tape indicator is blinking, no tape is loaded.
- When you are playing DVD at programmed Recording time, the unit automatically change to **VCR** mode and start recording.
- The unit will automatically power off when **Timer Recording** ends.

Checking or Erasing the Timer Program

Programming can be checked whenever the unit is turned on.

1. Press **SETUP MENU** and the main menu appears.
2. Use **▲ / ▼** to choose the **PROGRAM** menu and press **ENTER (OK)**.

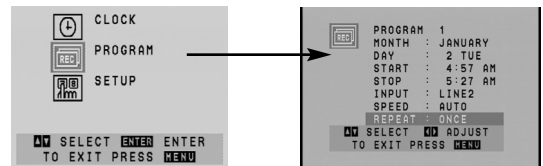

3. Use **◀ / ▶** to select a program you want to check or erase. To erase the program, press **CLEAR (0000)**.
4. Press **SETUP MENU** to return to the TV screen.

Program Priority

If the recording start and end times of preset programs overlap on the same day (see the example), the second program is not recorded until the first is finished.

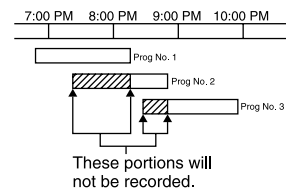

In this example, the first part of program numbers 2 and 3 are not recorded.

Timer-Link Recording (External Timer Recording)

Timer Link

If the external device such as Cable/Satellite box that is connected to this unit has the timer reservation function, this unit can record the input signal from external device via the timer LINE1 jack.

1. Connect the LINE1 input jacks on this unit to the AUDIO/VIDEO OUTPUT jack on the external device using the audio/video cables.
2. Set the timer reservation setting of the external device.
3. Turn off the external device.
4. Insert a video cassette with the safety tab intact to this unit. Select the recording speed with remote.
5. Press ● (REC) for more than 3 seconds on the front panel when the unit power is off.

The "Ⓞ" mark will flashes on the display window. This unit is set to standby mode for Timer-Link recording.

Notes:

- If the power of the external device is on by the timer reservation setting, this unit detects the signals of external device and start the recording automatically.
- If the power of the external device is off during external timer recording, this unit will be stop the external timer recording and turns off the power automatically.
- If the power of the external device is on again, this unit will be start the external timer recording again.
- Press ■ (STOP) to stop recording intentionally while external timer recording is in progress.
- The external timer record is available only for the device that is connected with LINE1 jack on this unit.
- Your external device such as Cable/Satellite box might keep running Audio/Video signals through the OUTPUT jack, even if the unit is powered off. If so, Timer-Link recording doesn't work.

- The external timer record will be set to off automatically when:
 - There is no recordable tape.
 - STOP or PAUSE button is pressed while external timer recording.
 - The power of this unit is ON in the external timer record standby mode.
 - When you press the ● (REC) for more than 3 seconds again in the external timer record standby mode.

Program Priority

If the recording time of this unit and the external device are overlap:

The earlier program takes priority. When the earlier program finishes, the later program starts.

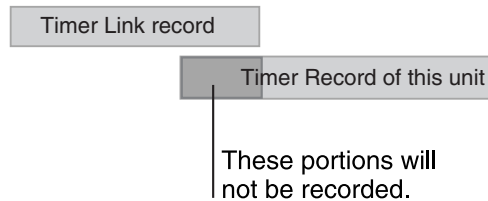

Copying from DVD to VCR

You can copy the contents of a DVD to a VHS tape.

1. Insert the disc you wish to copy into the DVD deck and close the disc tray.
2. Insert a blank VHS video tape into the VCR deck.
3. Find the place on the DVD from which you want to start dubbing using the PLAY, FF, REW and PAUSE functions.
For best results, pause playback at the point from which you want to record.
4. Press the ● (REC). The DVD goes into PLAY mode and the VCR goes into RECORD mode. If the DVD disc menu appears, you may need to press ► (PLAY) manually to begin copying.
5. Press || (PAUSE) during dubbing pauses both DVD play and VCR record functions.
Press || (PAUSE) again or press ● (REC) or ► (PLAY), the dubbing is resuming.
6. During dub PAUSING, you could find the wanted place in the disc for dubbing by using the FF, REW and SKIP search functions.
7. When the DVD is finished playing, press ■ (STOP) to end copying.

⚠ Caution

Do not use FF, REW and SKIP search functions during dubbing; otherwise you might record the unwanted video with no sound from disc.

Notes:

- You must stop the copy process manually when the DVD movie ends, or the unit may replay and record over and over again.
- When you stop the DVD playback during copying, the recording on VCR is stopped automatically.
- If the DVD disc is copy-protected, you will not be able to copy it using this unit.

On-Screen Display - VCR

Some of these functions will be displayed every time the unit is operated.

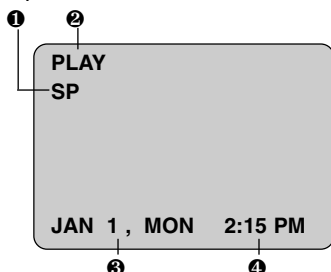

- | | |
|----------------------|--------------------------------|
| ❶ TAPE SPEED DISPLAY | ❸ DATE DISPLAY |
| ❷ FUNCTION DISPLAY | ❹ CLOCK/ COUNT/ REMAIN DISPLAY |

Each press of the ENTER (OK) changes the TV screen in the following sequence.

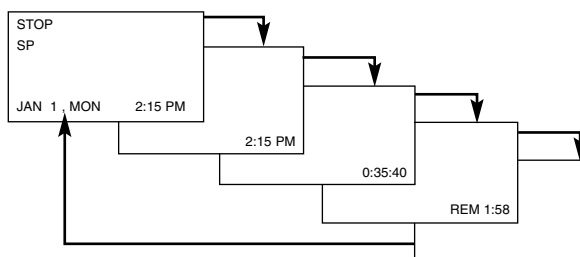

Real-Time Counter

If a tape with contents recorded on it is inserted into the VCR, the real-time counter shows length of the tape running in hours, minutes, and seconds. Press DISPLAY to select the real-time counter display. Every press of DISPLAY changes the TV screen as illustrated below.

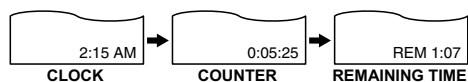

Counter Memory

This feature is useful if there is a section of tape you want to view immediately after recording or if you want to return to the same point several times.

1. Begin recording or playing a tape.
2. Press DISPLAY until the real-time counter is displayed on the TV screen.
3. At the point that you want to locate later, reset the real-time counter to "0:00:00" by pressing CLEAR (0000).
4. Continue to play or record.
5. Press ■ (STOP) when recording or playback finishes.
6. Press ◀◀ (REW). The tape automatically stops when the tape counter returns to about "0:00:00".

Tape Remaining

This function displays the amount of time remaining on the tape during recording or playback. Press DISPLAY repeatedly until the REM indicator displays on the TV screen during recording or playback. The remaining tape length may not be displayed correctly depending on the condition of the tape and the kind of the tape (T-140, T-160, or T-210 etc.).

Notes:

- The function displays can be seen displayed on the TV screen for 5 seconds.
- The clock (or tape counter, tape remaining) mode will be displayed until you press ENTER (OK).
- The tape counter and the remaining tape length indicator appear only when a cassette is inserted. Also, the remaining tape length indicator appears after any tape operation.

Additional VCR Information

- During manual recording playback, or fast forward modes, the unit automatically starts rewinding the tape at the end of the tape. The cassette stops at the beginning of the tape and is ejected.
- After you have finished using the unit, rewind, eject, and remove the cassette. Place the cassette in its protective sleeve to protect it from dust. It is not necessary to rewind the cassette before removing it, but if you do, it is ready to play or record the next time you use it.
- Do not attempt to hook up more than one television set to the unit for either recording or playback.

VCR Auto Play System

This unit features automatic playback.

When you load a tape with the safety tab removed the following occurs:

- The Output Source is changed to VCR mode automatically.
- The power turns on automatically and playback begins.
- At the end of the tape, the unit stops, then rewinds.
- The tape is ejected after rewinding and the turns itself off automatically.

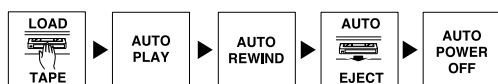

Note:

Auto power off does not function during regular DVD play mode. (unit power stays on.)

S-VHS Quasi Playback (SQPB)

- This unit can playback S-VHS recorded tapes; however, it cannot record in S-VHS format, but VHS format only.
- SQPB is an abbreviation for S-VHS Quasi Playback.

DVD Disc Playback (General Features)

Buttons	Operations	Discs
▲ (OPEN / CLOSE)	Opens or closes the disc tray.	ALL
⏸ (PAUSE)	During playback, press ⏸ to pause playback. Press ⏸ repeatedly to play Frame-by-Frame.	ALL DVD VCD DivX
⏮ / ⏭ (SKIP)	During playback, press ⏮ or ⏭ to go to the next chapter/track or to return to the beginning of the current chapter/track. Press ⏮ twice briefly to step back to the previous chapter/track.	ALL ACD
⏪ / ⏩ (REW/FF)	During playback, press ⏪ or ⏩ repeatedly to select the required scan speed. DVD, DivX disc; 4 steps Video CD, Audio CD ; 3 steps While the playback is paused, press ⏩ repeatedly to play in slow motion (4 steps).	DVD ACD DVD VCD DivX
REPEAT	During playback, press REPEAT repeatedly to select a desired repeat mode. DVD discs: Chapter/Title/Off Video CD, Audio CD, DivX disc : Track/All/Off	ALL
REPEAT A-B	Press the REPEAT A-B button one at a time to select a point A and point B and repeats a sequence from point A (Starting point) to point B (End point).	DVD VCD ACD
ZOOM	During playback or pause mode, press ZOOM to enlarge the video image (3 steps). You can move through the zoomed picture using ◀ ▶ ▲ ▼ buttons. Press CLEAR (0000) to exit.	DVD VCD DivX
RANDOM	During playback or in stop mode, press RANDOM for random playback.	ACD
TITLE	If the current DVD title has a menu, the title menu appears on the screen. Otherwise, the disc menu may appear.	DVD
DISC MENU	The disc menu appears on the screen.	DVD
ANGLE	During playback of DVD disc that contains scenes recorded at different camera angles, press ANGLE repeatedly to select a desired angle.	DVD
SUBTITLE	During playback, press SUBTITLE repeatedly to select a desired subtitle language.	DVD DivX
A.MONITOR	During playback, press A.MONITOR repeatedly to hear a different audio language or audio track.	DVD VCD DivX

Notes on general features:

- If you press **▶▶** once during Repeat Chapter (Track) playback, the repeat playback cancels.
- Zoom may not work on some DVDs.
- When you are playing a DVD disc that contains scenes recorded different camera angles, the angle indicator will blink on the TV screen during the operations as an indication that angle switching is possible.
- The A-B repeat function is available only in the current track.

Additional features

Time Search **DVD** **VCD** **DivX**

To start playing at any chosen time on the disc:

1. Press DISPLAY during playback.
2. Press **▲** / **▼** to select the time clock icon and "--:--:--" appears.
3. Input the required start time in hours, minutes, and seconds from left to right. If you enter the wrong numbers, press CLEAR (0000) to remove the numbers you entered. Then input the correct numbers.
4. Press ENTER (OK) to confirm. Playback starts from the selected time.

Marker Search **DVD** **VCD** **DivX**

To enter a Marker

You can start playback from up to nine memorized points. To enter a marker, press MARKER at the desired point on the disc. The Marker icon appears on the TV screen briefly. Repeat to enter up to nine markers.

To Recall or Clear a Marked Scene

1. During disc playback, press SEARCH. The marker search menu appears on the screen.
2. Within 10 seconds, press **◀** / **▶** to select a marker number that you want to recall or clear.
3. Press ENTER (OK) and playback starts from the marked scene. Or, Press CLEAR (0000) and the marker number is erased from the list.
4. You can play any marker by inputting its number on the marker search menu.
5. Press **■** (STOP) twice, clear all markers.

Last Scene Memory **DVD** **VCD**

This player memorizes last scene from the last disc that is viewed. The last scene remains in memory even if you remove the disc from the player or switch off the player. If you load a disc that has the scene memorized, the scene is automatically recalled.

Note:

This player does not memorize the scene of a disc if you switch off the player before commencing to play the disc.

Screen Saver

The screen saver appears when you leave the unit in Stop mode for about five minutes.

Playing an Audio CD

This unit can play Audio CDs.

Audio CD

Once you insert an Audio CD, a menu appears on the TV screen.

Press ▲ / ▼ to select a track/file then press ► (PLAY) or ENTER (OK) and playback starts. You can use variable playback functions. Refer to page 24-25.

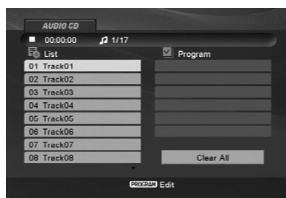

Programmed Playback

The program function enables you to store your favorite tracks from any disc in the player memory. A program can contain 30 tracks.

1. Insert an Audio CD recorded media. AUDIO CD menu appears.
2. Press PROGRAM and the Ⓜ mark will appear.

Note:

Press PROGRAM again to exit the program edit mode, then the Ⓜ mark will disappear.

3. Select a track on the "List", then press ENTER (OK) to place the selected track on the "Program" list. Repeat to place additional tracks on the list.
4. Select the track you want to start playing on the "Program" list.
5. Press ► (PLAY) or ENTER (OK) to start. Playback begins in the order in which you programmed the tracks. Playback stops after all of the tracks on the "Program" list have played once.
6. To resume normal playback from programmed playback, select a track on the list and then press ► (PLAY).

Repeat Programmed Tracks

Press REPEAT to select a desired repeat mode.

- Track: repeats the current track
- All: repeats all the tracks on programmed list.
- Off(No display): does not play repeatedly.

Note:

If you press ►► once during Repeat Track playback, the repeat playback cancels.

Erasing a Track from "Program" List

1. During STOP mode, press PROGRAM and the Ⓜ mark will appear.
2. Use ▲▼◀▶ to select the track that you wish to erase from the Program list.
3. Press CLEAR (0000). Repeat step 1~3 to erase additional tracks on the list.

Erasing the Complete Program List

1. During STOP mode, press PROGRAM and the Ⓜ mark will appear.
2. Use ▲▼◀▶ to select "Clear All", then press ENTER (OK).

Note:

The programs are also cleared when the power is off or the disc is removed.

Viewing a JPEG file

This unit can play JPEG files.

1. Insert a disc of JPEG files. The PHOTO menu appears on the TV screen.

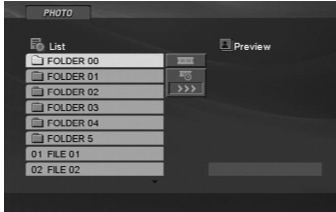

2. Press ▲ / ▼ to select a folder, and press ENTER (OK). A list of files in the folder appears.
3. If you want to view a particular file, press ▲ / ▼ to highlight a file and press ENTER (OK) or ► (PLAY).
4. To return to the PHOTO menu while watching pictures, press ■ (STOP).

Note :

Some kind of special JPEG file can be taken more time to play than normal JPEG.
(ex. Progressive JPEG)

Tips:

- If you are in a file list and want to return to the previous Folder list, use ▲ / ▼ buttons to highlight and press ENTER (OK).
- Press DISC MENU to move to the next page.
- There are three Slide Speed options : >>> (Fast), >> (Normal) and > (Slow). Use ▲ ▼ ◀ ▶ to highlight . Then, use ◀ / ▶ to select the option you want to use then press ENTER (OK).
- While watching a picture, press (RETURN) to hide the help menu.

Slide Show

Use ▲ ▼ ◀ ▶ to highlight the (Slide Show) then press ENTER (OK).

Still Picture

1. Press (PAUSE) during slide show. The player will now go into PAUSE mode.
2. To return to the slide show, press (PLAY) or press (PAUSE) again.

Moving to another File

Press or or cursor (◀ or ▶) once while viewing a picture to advance to the next or previous file.

Zoom

During watching pictures, press ZOOM to enlarge the video image (3 steps).

You can move through the zoomed picture using ◀ ▶ ▲ ▼ buttons.

Rotating the picture

Press ▲ / ▼ during showing a picture to rotate the picture clockwise or counter clockwise.

JPEG disc compatibility with this player is limited as follows:

- Depending upon the size and the number of JPEG files, it could take a long time for the DVD player to read the disc's contents. If you do not see an on-screen display after several minutes, some of the files may be too large — reduce the resolution of the JPEG files to less than 5 million pixels and burn another disc.
- The total number of files in a folder should be less than 1000 files.
- Some discs may be incompatible due to a different recording format or the condition of disc.
- Ensure that all the selected files have the “.jpg” extensions when copying into the CD layout.
- If the files have “.jpe” or “.jpeg” extensions, please rename them as “.jpg” file.
- File names without “.jpg” extension will not be able to be read by this DVD player. Even though the files are shown as JPEG image files in Windows Explorer.

Playing a DivX Movie file

Using this DVD Player you can play DivX file.

1. Insert a disc of DivX files. The MOVIE menu appears on the TV screen.

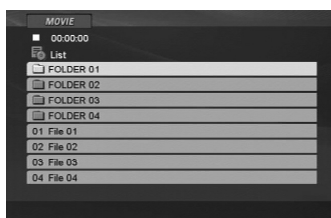

2. Press ▲ / ▼ to select a folder, and press ENTER (OK). A list of files in the folder appears.
3. If you want to view a particular file, press ▲ / ▼ to highlight a file and press ENTER (OK) or ► (PLAY).
You can use variable playback functions. Refer to page 24-25.
4. Press ■ (STOP) to stop the playback. The Movie menu appears.

Tips:

- If you are in a file list and want to return to the previous Folder list, use the ▲ / ▼ buttons on the remote to highlight and press ENTER.
- Press DISC MENU to move to the next page.
- On a CD with JPEG and MOVIE file, you can switch PHOTO and MOVIE menu. Press TITLE and PHOTO and MOVIE word on top of the menu is highlighted.
- The disc subtitle may not be displayed properly, if a DivX subtitle is downloaded through the internet.
- If the Disc Subtitle setup menu does not have the DivX subtitle language you are going to play, the subtitle may not be displayed properly.

Notice for displaying the DivX subtitle

If the subtitle does not display properly during playback, press and hold SUBTITLE about 3 seconds then press ◀ / ▶ to select another language code until the subtitle is displayed properly.

Note :

The DivX subtitle file name has to be identified with the DivX file name to display by this unit

DivX disc compatibility with this player is limited as follows:

- Available resolution size of the DivX file is under 720x576 (W x H) pixel.
- The file name of the DivX subtitle is available by 56 characters.
- If there is impossible code to express in the DivX file, it may be displayed as “_” mark on the display.
- **If the number of the screen frame is over 30 per 1 second, this unit may not operate normally.**
- **If the video and audio structure of recorded file is not interleaved, either video or audio is outputted.**
- **If the file is recorded with GMC, the unit supports only 1-point of the record level.**
* GMC?
GMC is the acronym for Global Motion Compensation. It is an encoding tool specified in MPEG4 standard. Some MPEG4 encoders, like DivX, have this option.
There are different levels of GMC encoding, usually called 1-point, 2-point, or 3-point GMC.

Playable DivX file

.avi, .mpg, .mpeg

Playable Subtitle format

SubRip(*.srt/* .txt)
SAMI(*.smi)
SubStation Alpha(*.ssa/* .txt)
MicroDVD(*.sub/* .txt)
SubViewer 1.0(*.sub)
SubViewer 2.0(*.sub/* .txt)
TMPlayer(*.txt)

Playable Codec format

“DIVX3.xx”, “DIVX4.xx”, “DIVX5.xx”, “MP43”, “3IVX”.

Playing a DVD VR format Disc

This unit will play DVD-R/RW discs that are recorded using the DVD-Video format that have been finalized using a DVD-recorder.

This unit will play DVD-RW discs that are recorded using the Video Recording (VR) format.

1. Insert a disc and close the tray, and playback start automatically.
2. Press TITLE to move to the list menu.

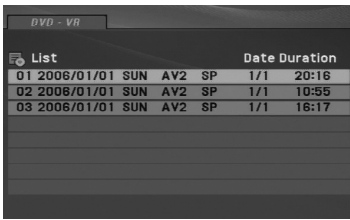

3. Press ▲ / ▼ to select a track then press ► (PLAY) or ENTER (OK) and playback starts.
4. Press ■ (STOP) to stop the playback.

Notes:

- Unfinalized DVD-R/RW discs cannot be played in this player.
- Some DVD-VR disc are made with CPRM data by DVD RECORDER. Player does not support these kinds of discs and display the "CHECK DISC".

What is 'CPRM'?

CPRM is a copy protection system (with scramble system) only allowing the recording of 'copy once' broadcast programs. CPRM stands for Content Protection for Recordable Media.

Maintenance and Service

Refer to the information in this chapter before contacting a service technician.

Handling the Unit

When shipping the unit

Please save the original shipping carton and packing materials. If you need to ship the unit, for maximum protection, re-pack the unit as it was originally packed at the factory.

Keeping the exterior surfaces clean

- Do not use volatile liquids such as insecticide spray near the unit.
- Do not leave rubber or plastic products in contact with the unit for a long period of time. since they leave marks on the surface.

Cleaning the unit

To clean the player, use a soft, dry cloth. If the surfaces are extremely dirty, use a soft cloth lightly moistened with a mild detergent solution.

Do not use strong solvents such as alcohol, benzene, or thinner, as these might damage the surface of the unit.

Maintaining the Unit

The unit is a high-tech, precision device. If the optical pick-up lens and disc drive parts are dirty or worn, the picture quality could be diminished.

Depending on the operating environment, regular inspection and maintenance are recommended after every 1,000 hours of use.

For details, please contact your nearest authorized service center.

Reference

Language Codes

Use this list to input your desired language for the following initial settings:
Disc Audio, Disc Subtitle, Disc Menu.

Language	Code	Language	Code	Language	Code	Language	Code
Abkhazian	6566	Fiji	7074	Lingala	7678	Singhalese	8373
Afar	6565	Finnish	7073	Lithuanian	7684	Slovak	8375
Afrikaans	6570	French	7082	Macedonian	7775	Slovenian	8376
Albanian	8381	Frisian	7089	Malagasy	7771	Somali	8379
Ameharic	6577	Galician	7176	Malay	7783	Spanish	6983
Arabic	6582	Georgian	7565	Malayalam	7776	Sudanese	8385
Armenian	7289	German	6869	Maltese	7784	Swahili	8387
Assamese	6583	Greek	6976	Maori	7773	Swedish	8386
Aymara	6588	Greenlandic	7576	Marathi	7782	Tagalog	8476
Azerbaijani	6590	Guarani	7178	Moldavian	7779	Tajik	8471
Bashkir	6665	Gujarati	7185	Mongolian	7778	Tamil	8465
Basque	6985	Hausa	7265	Nauru	7865	Tatar	8484
Bengali; Bangla	6678	Hebrew	7387	Nepali	7869	Telugu	8469
Bhutani	6890	Hindi	7273	Norwegian	7879	Thai	8472
Bihari	6672	Hungarian	7285	Oriya	7982	Tibetan	6679
Breton	6682	Icelandic	7383	Panjabi	8065	Tigrinya	8473
Bulgarian	6671	Indonesian	7378	Pashto, Pushto	8083	Tonga	8479
Burmese	7789	Interlingua	7365	Persian	7065	Turkish	8482
Byelorussian	6669	Irish	7165	Polish	8076	Turkmen	8475
Cambodian	7577	Italian	7384	Portuguese	8084	Twí	8487
Catalan	6765	Japanese	7465	Quechua	8185	Ukrainian	8575
Chinese	9072	Javanese	7487	Rhaeto-Romance	8277	Urdu	8582
Corsican	6779	Kannada	7578	Rumanian	8279	Uzbek	8590
Croatian	7282	Kashmiri	7583	Russian	8285	Vietnamese	8673
Czech	6783	Kazakh	7575	Samoan	8377	Volapük	8679
Danish	6865	Kirghiz	7589	Sanskrit	8365	Welsh	6789
Dutch	7876	Korean	7579	Scots Gaelic	7168	Wolof	8779
English	6978	Kurdish	7585	Serbian	8382	Xhosa	8872
Esperanto	6979	Laothian	7679	Serbo-Croatian	8372	Yiddish	7473
Estonian	6984	Latin	7665	Shona	8378	Yoruba	8979
Faroese	7079	Latvian, Lettish	7686	Sindhi	8368	Zulu	9085

Troubleshooting

Check the following guide for the possible cause of a problem before contacting service.

Symptom	Cause	Correction
No power.	<ul style="list-style-type: none"> The AC power plug is disconnected from the AC outlet. 	<ul style="list-style-type: none"> Connect the AC power plug to the AC outlet securely.
Abnormal or no picture	<ul style="list-style-type: none"> The TV is not set to receive unit signal output. 	<ul style="list-style-type: none"> Insert a disc or tape. (Check that the disc or tape indicator in the display window is lit.)
	<ul style="list-style-type: none"> The video cable is not connected securely. 	<ul style="list-style-type: none"> Select the appropriate video input mode on the TV so the picture from the unit player appears on the TV screen.
	<ul style="list-style-type: none"> Unit output setting. 	<ul style="list-style-type: none"> Check TV capability. Check mode of connections (eg. Components etc.).
	<ul style="list-style-type: none"> Wrong cable connection. 	<ul style="list-style-type: none"> The cable is correctly connected.
Distorted or no sound.	<ul style="list-style-type: none"> The equipment connected with the audio cable is not set to receive unit signal output. 	<ul style="list-style-type: none"> Select the correct input mode of the audio receiver so you can listen to the sound from the unit.
	<ul style="list-style-type: none"> The audio cables are not connected securely. 	<ul style="list-style-type: none"> Connect the audio cable into the jacks securely.
	<ul style="list-style-type: none"> The power of the equipment connected with the audio cable is turned off. 	<ul style="list-style-type: none"> Turn on the equipment connected with the audio cable.
	<ul style="list-style-type: none"> The AUDIO options are set to the wrong position. 	<ul style="list-style-type: none"> Set the AUDIO options to the correct position.
The playback picture is poor.	<ul style="list-style-type: none"> The disc is dirty. 	<ul style="list-style-type: none"> Clean the disc.
	<ul style="list-style-type: none"> The TV channels are not tuned in properly. 	<ul style="list-style-type: none"> The input source of TV is corrected.
	<ul style="list-style-type: none"> Tape heads are dirty. 	<ul style="list-style-type: none"> Clean video heads.
	<ul style="list-style-type: none"> Tape is a rental or was recorded on another VCR. 	<ul style="list-style-type: none"> Use ▲/▼ (-/+) for manual tracking adjustment while tape is playing.
The unit does not start playback.	<ul style="list-style-type: none"> No disc is inserted. No tape is inserted. 	<ul style="list-style-type: none"> Insert a disc or tape. (Check that the disc or tape indicator in the display window is lit.)
	<ul style="list-style-type: none"> An unplayable disc is inserted. 	<ul style="list-style-type: none"> Insert a playable disc. (Check the disc type and Regional code.)
	<ul style="list-style-type: none"> The disc is placed upside down. 	<ul style="list-style-type: none"> Place the disc with the playback side down.
	<ul style="list-style-type: none"> The disc is not placed within the guide. 	<ul style="list-style-type: none"> Place the disc on the disc tray correctly inside the guide.
	<ul style="list-style-type: none"> The disc is dirty. 	<ul style="list-style-type: none"> Clean the disc.
	<ul style="list-style-type: none"> The Rating level is set. 	<ul style="list-style-type: none"> Cancel the Rating function or change the Rating level.

Symptom	Cause	Correction
Video tape cannot be inserted.	<ul style="list-style-type: none"> The cassette tape is already loaded. 	<ul style="list-style-type: none"> Eject the cassette tape.
No Hi-Fi sound	<ul style="list-style-type: none"> Audio mode is not set properly. 	<ul style="list-style-type: none"> Select STEREO by repeatedly pressing A.MONITOR on the Remote Control.
The Remote Control does not work properly.	<ul style="list-style-type: none"> There is an obstacle in the path of the Remote Control and this unit. 	<ul style="list-style-type: none"> Remove the obstacle.
	<ul style="list-style-type: none"> The batteries in the Remote Control are exhausted. 	<ul style="list-style-type: none"> Replace the batteries with new ones.
	<ul style="list-style-type: none"> The Remote Control is not pointed at the remote sensor of the unit. 	<ul style="list-style-type: none"> Point the Remote Control at the remote sensor of the unit.
	<ul style="list-style-type: none"> The remote control is too far from the unit. 	<ul style="list-style-type: none"> Operate the Remote Control within 23ft (7m).
	<ul style="list-style-type: none"> This Remote Control use the same buttons for VCR and DVD functions (ex.PLAY). 	<ul style="list-style-type: none"> When using a VCR, first press the VCR button. When using a DVD, first press the DVD button.
	<ul style="list-style-type: none"> The current remote control code does not match the unit. 	<ul style="list-style-type: none"> Identify the remote control code with the code of unit. (See page 17).
Camcorder image is not shown.	<ul style="list-style-type: none"> Camcorder is off. 	<ul style="list-style-type: none"> Turn camcorder on and operate properly.
Camcorder image via AV input to unit is not shown on TV screen.	<ul style="list-style-type: none"> Unit SOURCE SELECT is not set to LINE1 or LINE2. 	<ul style="list-style-type: none"> Press AUX to select LINE input channel (LINE1 or LINE2).

Specifications

General

Power requirements	120V, 60 Hz
Power consumption	16 W
Dimensions (approx.)	16.9" X 3.1" X 10.2" (430 X 79 X 260 mm) (w x h x d)
Net Weight (approx.)	8.8 lbs (4.0 kg)
Operating temperature	5°C to 40°C (41°F to 104°F)
Operating humidity	5 % to 90 %
Signal system	NTSC

Inputs

VHS VIDEO IN(LINE1, 2)	1 V (p-p) 75 ohms, sync negative, RCA jack x 2
VHS AUDIO IN(LINE1, 2)	-6.0 dBm more than 47 ohms, RCA jack (L, R) x 2

Outputs

VIDEO OUT	1 V (p-p) 75 ohms, sync negative
COMPONENT VIDEO OUT (PROGRESSIVE SCAN)	(Y) 1.0 V (p-p), 75 ohms, negative sync, RCA jack x 2 (Pb)/(Pr) 0.7 V (p-p), 75 ohms, RCA jack x 2
Audio output (digital audio)	0.5 V (p-p), 75 ohms, RCA jack x 1
Audio output (analog audio)	2.0 Vrms (1 KHz, 0 dB), 600 ohms, RCA jack (L, R) x 2

VCR Specifications

Head system	Four head helical scan azimuth system
Timer	12-hour display type with AM, PM
Tape speed	SP: 33.35 mm/sec, LP: 16.67 mm/sec, SLP: 11.12 mm/sec
Tape width	12.7 mm
Maximum recording time	SP: 2 HOURS (T-120), SLP: 6 HOURS (T-120)/8 HOURS (T-160)
Rewind time	About 3 minutes (T-120)
Frequency range	20 Hz to 20 kHz
Signal-to-noise ratio	More than 43 dB
Dynamic range	More than 88 dB
Channel separation	More than 60 dB

DVD Specifications

Laser system	Semiconductor laser, wavelength 650 nm
Frequency response	DVD (PCM 96 kHz): 8 Hz to 44 kHz, DVD (PCM 48 kHz): 8 Hz to 22 kHz CD: 8 Hz to 20 kHz
Signal-to-noise ratio	More than 90 dB (ANALOG OUT jacks only)
Harmonic distortion	Less than 0.02%
Dynamic range	More than 95 dB (DVD/CD)

Accessories:

Video cable x 1, Audio cable (L/R) x 1, Remote control x 1, Batteries (R03/AAA) x 2

Note : Design and specifications are subject to change without prior notice.

Warranty (Only in U.S.A.)

JVC® **LIMITED WARRANTY** **EXCHANGE-90**

JVC COMPANY OF AMERICA warrants this product and all parts thereof, except as set forth below **ONLY TO THE ORIGINAL PURCHASER AT RETAIL** to be **FREE FROM DEFECTIVE MATERIALS AND WORKMANSHIP** from the date of the original retail purchase for the period shown below. ("The Warranty Period")

LABOR 90 DAYS	PARTS 90DAYS
----------------------	---------------------

THIS LIMITED WARRANTY IS VALID ONLY IN THE FIFTY (50) UNITED STATES, THE DISTRICT OF COLUMBIA AND IN THE COMMONWEALTH OF PUERTO RICO.

WHAT WE WILL DO:
If this product is found to be defective within the warranty period, JVC will, at its option, either repair or replace the defective part(s) or replace the product with a new or refurbished functionally equivalent product. Within 90 days from date of retail sale, repair or replacement will be at no charge to the customer.

WHAT YOU MUST DO FOR WARRANTY SERVICE:
Please do not return your product to the retailer. Instead, please box the product carefully, preferably in the original carton, and ship, insured to the JVC repair/replacement facility nearest you.

To obtain the address of the location nearest you, please call (800) 252-5722 or visit our website at <http://www.jvc.com>

A COPY OF YOUR BILL OF SALE, A COMPLETED WARRANTY REPAIR/REPLACEMENT FORM AND ALL OF THE ORIGINAL ACCESSORIES WHICH CAME WITH YOUR UNIT MUST ACCOMPANY THE PRODUCT TO BE ELIGIBLE FOR REPAIR/REPLACEMENT UNDER WARRANTY.

If you have any questions concerning your JVC Product, please contact our Customer Care Center at (800) 252-5722.

WHAT IS EXCLUDED:
The warranty does not cover:

1. Products which have been subject to abuse, accident, alteration, modification, tampering, negligence, misuse, faulty installation, lack of reasonable care, or if repaired or serviced by anyone other than a service facility authorized by JVC to render such service, or if affixed to any attachment not provided with the products, or if the model or serial number has been altered, tampered with, defaced or removed.
2. Initial installation, installation and removal, from "built in" entertainment centers, and other mounting systems.
3. Operational adjustments covered in the Owner's Manual, normal maintenance, including head cleaning.
4. Damage that occurs in shipment, due to act of God, and cosmetic damage.
5. Signal reception problems and failures due to line power surge.
6. Products used for commercial purposes (including but not limited to rental).
7. Accessories.
8. Batteries (except that Rechargeable Batteries are covered for 90 days from the date of purchase).
9. Loss of data resultant from malfunction of hard drive or other data storage device.

There are no express warranties except as listed above.

AFTER THE WARRANTY:
Please contact JVC's Customer Care Center at (800) 252-5722 to obtain the cost of out of warranty repair or replacement.

THE DURATION OF ANY IMPLIED WARRANTIES, INCLUDING THE IMPLIED WARRANTY OF MERCHANTABILITY, IS LIMITED TO THE DURATION OF THE EXPRESS WARRANTY HEREIN.

JVC SHALL NOT BE LIABLE FOR ANY LOSS OF USE OF THE PRODUCT, INCONVENIENCE, OR ANY OTHER DAMAGES, WHETHER DIRECT, INCIDENTAL OR CONSEQUENTIAL (INCLUDING, WITHOUT LIMITATION, DAMAGE TO TAPES, RECORDS OR DISCS) RESULTING FROM THE USE OF THIS PRODUCT, OR ARISING OUT OF ANY BREACH OF THIS WARRANTY. ALL EXPRESS AND IMPLIED WARRANTIES, INCLUDING THE WARRANTIES OF MERCHANTABILITY AND FITNESS FOR PARTICULAR PURPOSE, ARE LIMITED TO THE WARRANTY PERIOD SET FORTH ABOVE.

Some states do not allow the exclusion of incidental or consequential damages or limitations on how long an implied warranty lasts, so these limitations or exclusions may not apply to you. This warranty gives you specific legal rights and you may also have other rights which vary from state to state.

JVC COMPANY OF AMERICA **1700 Valley Road**
DIVISION OF JVC AMERICAS CORP. Wayne, New Jersey 07470
<http://www.jvc.com>

REFURBISHED PRODUCTS CARRY A SEPARATE WARRANTY, THIS WARRANTY DOES NOT APPLY. FOR DETAIL OF REFURBISHED PRODUCT WARRANTY, PLEASE REFER TO THE REFURBISHED PRODUCT WARRANTY INFORMATION PACKAGED WITH EACH REFURBISHED PRODUCT.

For customer use:

Enter below the Model No. and Serial No. which is located either on the rear, bottom or side of the cabinet. Retain this information for future reference.

Model No.: _____ Serial No.: _____

Purchase Date : _____ Name Of Dealer : _____



WARRANTY REPAIR / REPLACEMENT FORM

PLEASE COMPLETE THE FOLLOWING;

PLEASE NOTE : P.O. BOXES ARE NOT ACCEPTABLE

NAME: _____

STREET ADDRESS: _____

CITY: _____ STATE _____ ZIPCODE _____

DAY TIME PHONE NUMBER: _____

REASON FOR RETURN _____

Please do not return your product to the retailer. Instead, please box the product carefully, preferably in the original carton, and ship, insured to the JVC repair/replacement facility nearest you.

A COPY OF YOUR BILL OF SALE, A COMPLETED WARRANTY REPAIR/REPLACEMENT FORM AND ALL OF THE ORIGINAL ACCESSORIES WHICH CAME WITH YOUR UNIT MUST ACCOMPANY THE PRODUCT TO BE ELIGIBLE FOR REPAIR/REPLACEMENT UNDER WARRANTY.

To obtain the address of the location nearest you, please call (800) 252-5722 or visit our website <http://www.jvc.com>.

If you have any questions concerning your JVC Product, please contact our Customer Care Center at (800) 252-5722.

BT-51025-6
(0705)



US Printed in Indonesia
0207MNH-OT-OT
P/N: MFL37329833